

EMMO E-WILD PRO

OWNER'S MANUAL



Preface

An Important Message From EMMO

Thank you for choosing EMMO. Congratulations on your purchase of a new E-Wild Pro.

This document is intended as a short introduction to your new e-bike. It contains essential safety, performance and service information. Please read and understand this manual fully before assembling and riding your bike. Be sure to watch the official Emmo E-Wild Pro assembly video available at <https://emmo.ca/pages/e-bike-assembly-guide>.

Additional information about your bike can be found on our website at www.emmo.ca.

Be sure to check all hardware for correct torque during assembly.

Illustrations

Illustrations shown in this document may differ in detail from the exact configuration on your particular e-bike model. The illustrations are a general reference for instruction and description purposes only.

Service & Support

If you have questions after reading this manual and watching the assembly video, please feel free to contact us.

E-mail: service@emmo.ca

Toll Free: 1-888-217-1217

Find Emmo dealers near you: <https://emmo.ca/pages/locations>

Content

About This Manual	5
About EMMO	6
Rules and Regulations	7
Safety Disclaimer	11
Description	15
Schematic Diagram	15
Side View	15
Handlebar Attachments	16
Operation Guide	17
Speedometer & Control	17
Display	17
Navigation	19
Control Function.....	20
Function Summary.....	21
Bluetooth APP.....	46

Error Code	49
Adjusting the Seat Height.....	51
Adjusting the Saddle Position	52
Battery	53
Battery Strength Indicator.....	54
USB Port	55
Discharging port.....	56
Battery Lever.....	57
Battery Charging Port	58
Battery Lock.....	59
Battery Safety Precautions	62
Disposal.....	63
Storage & Maintenance	64
Charger	65
Charging Indicator.....	66
Charger Specification Label.....	67
Power Cord Socket	68

Power Cord	68
Charger Plug	69
Charging Precautions	70
Gear Shifter.....	72
Throttle	73
Adjusting the Suspension Fork	74
Cleaning / Lubricating the Chain.....	75
Tire Pressure	76
Serial Number.....	78
Troubleshooting	80
Riding Guide	85
Checking List Before Riding	85
Warranty Policy	86
E-Bike Registration	89
Leave Us a Review	91
Contact Us.....	92

About This Manual

This document is intended as a short introduction to your new e-bike. It contains important safety, performance and service information. Read and understand it along with the information provided during the on-delivery instructions before using the product. Pay special attention to the safety messages as shown here, and keep the manual handy for future reference.



WARNING: Warning about a situation that can cause death, serious physical injury and or heavy material damage if one does not obey the safety instructions.



DANGER: Danger statement indicates a hazardous situation that, if not avoided, has a very high risk of death, serious injury, or property damage.



CAUTION: Caution statement indicates a hazardous situation that, if not avoided, could result in minor or moderate injury or property damage.



NOTICE: Notice is important information that can help you avoid bike/property damage or extend the life of parts and the bike.

About EMMO

Emmo is a proud Canadian company based in Toronto, Ontario. As the leading brand of electric bikes, Emmo has provided over 500,000 people with environmentally-friendly transportation throughout North America. We believe that electric mobility for everyone is a big step in moving towards a zero-emission future.

Since 2009, Emmo has offered a large selection of electric mobility options for commuting and recreation. With our diversity of products, we create high-quality options to accommodate everyone's needs with an emphasis on reducing their carbon footprint. The past decade has proven that Emmo e-bikes are not only a sustainable method of transportation, but that they also push the limits of conventional bikes –to take you further, with less effort and more fun.

Driven by our vision of inspiring more people to lead a greener lifestyle, Emmo strives to give our riders' the best experience possible. Our in-house research and development spans two continents. Our e-bikes are designed in North America and undergo rigorous testing at our state-of-the-art facilities. Throughout this process, every facet of this complex supply chain is vigorously scrutinized to ensure the end product arrives in flawless condition at our four distribution centers in North America. We continue to be at the forefront of the e-bike industry. With over 100 retailers, Emmo is never too far away.

For over 13 years, our strong commitment to design and innovation has resulted in every Emmo product encompassing the latest technology. Our e-bikes exclusively use programmable sine-wave BLDC controllers, allowing higher performance, longer range and enhanced reliability in all conditions. Backed by our comprehensive warranty, we ensure riders are confident in the purchase of their Emmo.

Emmo believes that a greener future is not only possible, it's necessary, and we want to do our part to build greener communities by making e-bikes more accessible.

Rules and Regulations

According to **Canada's Motor Vehicle Safety Regulations (MVSR)**. A qualified e-bike (defined as Power Assist Bicycle) must meet the following requirements:

- The e-bike must have operational pedals
- Upper wattage limit for the motor is 500W
- Maximum speed of an e-bike is 32km/h.

Other requirements include a permanently affixed compliance label from the manufacturer stating that the vehicle is a power-assisted bicycle under statutory requirements in force at the time of manufacture. Currently, there is no license, no insurance, and no vehicle registration required to operate a qualified e-bike according to federal legislation. E-Bike riders share the same rights and responsibilities as other road users.

However, provinces and local municipalities have the power to restrict the use of e-bikes. Most provinces require the rider to wear a helmet. Some provinces have special requirements with regard to the age limit to operate an e-bike, the type of helmet required, even the number of wheels and wheel size. In Ontario, typically, e-bikes are generally treated the same as regular bicycles. According to the Ministry of Transportation of Ontario (MTO), the age limit to operate an e-bike is 16 years old and above; the maximum weight of the bike is 120 kilograms (265 pounds); the bike must have a brake distance of less than 9 meters; Any modifications made to the bike's motor to create speeds greater than 32km/h are prohibited.

The rules and regulations are subject to changes in different provinces and municipalities. Please check your municipal bylaw and see where you stand.

Rules and Regulations

Useful links:

E-Bike Regulations in Ontario:

<https://www.ontario.ca/page/riding-e-bike>

E-Bike Regulations in British Columbia:

https://www.bclaws.gov.bc.ca/civix/document/id/complete/statreg/151_2002

E-Bike Regulations in Alberta:

<http://www.transportation.alberta.ca/content/doctype45/production/mopedpowerbikes.pdf>

E-Bike Regulations in Manitoba:

<https://web2.gov.mb.ca/laws/statutes/ccsm/h060e.php>

E-Bike Regulations in Saskatchewan:

https://www.sgi.sk.ca/motorcycle/-/knowledge_base/motorcycle-handbook/power-assisted-bicycles1

E-Bike Regulations in Quebec:

<https://saaq.gouv.qc.ca/en/road-safety/modes-transportation/electric-bike>

E-Bike Regulations in New Brunswick:

https://www2.gnb.ca/content/gnb/en/services/services_renderer.200814.Motor_Vehicle_Registration.html

E-Bike Regulations in Nova Scotia:

<https://novascotia.ca/just/regulations/regs/mv18786.htm>

E-Bike Regulations in Prince Edward Island:

<https://www.princeedwardisland.ca/en/information/transportation-and-infrastructure/power-assisted-bicycles>

Know and obey all relevant local laws

It is your responsibility to research and understand relevant laws where you ride your bike. Such laws may cover required helmets and safety gear, required lights and reflectors, required hand signals, where you can legally ride a bike (bikes and ebikes may have different restrictions), how fast you can go, what (if any) cargo or passengers you can carry, rider age, and more. Before using public transportation—buses, trains, etc.—to transport your e-bike, check with the relevant transportation authority for any rules governing weight limits, tire widths, lithium-ion batteries, or any other rules that might pertain to e-bikes. When you ride on the road, assume you must, at minimum, follow all of the rules that cars must follow. For additional information regarding traffic and vehicle laws, contact the road traffic authority in your area.

The product(s) comply with federal regulations for this product category in Canada and with applicable provincial regulations in the region of sale at the time of purchase. In jurisdictions where the product(s) may NOT be compliant, the buyer acknowledges this possibility and accepts full responsibility for their use. The buyer is solely responsible for understanding and complying with all applicable laws, regulations, and bylaws related to the operation and use of the product(s) in their local area. If the product(s) are capable of going faster than the applicable legal speed limit, the

seller is NOT responsible for the speed at which the buyer operates the product(s). Any future changes to legislation or regulatory classification that affect where or how the product(s) may be used are outside the control of the seller and shall NOT constitute valid grounds for return, refund, or compensation. Such changes do NOT imply any defect or misrepresentation of the product(s) at the time of sale.

Safety Disclaimer

This manual contains important safety, performance, and service information. Read and understand it along with the information provided during the on-delivery instructions before using the product, and keep it for reference. Ensure that you comprehend all instructions and safety NOTes/warnings.

Definition: In this manual, the term “Vehicle” refers collectively to any bike, ebike, etrike, or similar vehicle sold or authorized by EMMO.

General Responsibility

- By choosing to ride a Vehicle, you assume full responsibility for all risks, including falls, collisions, equipment failure, and road or traffic hazards.
- Riders are responsible for following local laws and bylaws, practicing safe riding, and maintaining the Vehicle properly.
- Safe use depends on responsible riding, regular inspections, and timely replacement of worn components.



WARNING: Fit & Capability

- Ensure the Vehicle fits you properly before riding; incorrect sizing may cause loss of control.
- Riders must have sufficient physical condition, reaction time, and mental capability to handle traffic and emergencies. If you have medical conditions (including impairments or seizure disorders), consult your physician before riding.
- Before the first ride, practice braking and throttle control in a safe environment.

- If riding at night, familiarize yourself with the lights and signals and ensure they function properly.



WARNING: Installation & Maintenance

- Improper installation, compatibility issues, or poor maintenance can cause serious injury or death.
- Secure all hardware (handlebar, grips, seat, pedals, etc.) before each ride.
- Have the Vehicle inspected by an authorized technician at least once every 6 months.
- It is your full responsibility to ensure the Vehicle is in good working order at all times. Perform a pre-ride safety check before every ride (brakes, throttle, sensors, lights, and other key components).



WARNING: Battery & Charger Safety

- The charger should only be used **indoors** in a cool, dry, ventilated area. Always position the charger on a **non-flammable surface** (e.g., concrete or brick), as it may generate heat during peak charging cycles.
- You must use a **dedicated 110V outlet** to charge your battery.
- Never cover the charger during charging or leave it unattended.
- Keep the battery and charger away from children, pets, water, and open flame.
- DO NOT submerge or allow the charger to be submerged in water or any liquid.
- **DO NOT** use the charger or battery if **any part of the cord, connector, or housing is frayed, cracked, exposed, or otherwise damaged**. Using damaged charging equipment or battery connectors can lead to malfunction, fire, or serious injury.
- Do NOT drop, strike, or expose them to shocks.

- Use only the charger supplied with the product or approved by EMMO.
- Disconnect promptly once fully charged. Do NOT charge for more than **12 hours**, whether the battery is full or not.
- If the battery is stored, check it at least **once a month**. If necessary, use the original charger to recharge the battery to about **75%**. Failure to perform regular checks or charging may result in malfunction or safety hazards.
- Disconnect immediately if there is a strange smell, smoke, or overheating.
- In the unlikely case of battery fire: **never use water**. Use sand to cover the fire and call emergency services.
- **Battery & Charger Rated Life Expectancy:** Lead-Acid Battery: 2 years (500 cycles); Lithium-Ion Battery: 4 years (1000 cycles); Charger: 4 years. All component lifespans assume normal use and proper maintenance. **Annual inspection & safety testing by an authorized technician are required to ensure safety.** Components that have exceeded their rated service life—or no longer provide expected performance—should be replaced to ensure safety and reliability. While proper care may extend usable life, this can NOT be guaranteed.



WARNING: Modifications & Non-Original Components

- Do NOT use the Vehicle with trailers, stands, racks, or accessories that are not approved by EMMO. The use of non-original components or spare parts can jeopardize the safety of your Vehicle, void your warranty, and, in some cases, cause your Vehicle to not conform with applicable laws.
- Any unauthorized modifications (to the electrical system, controller, battery, or structural components) may compromise safety. **Such modifications void the warranty and are performed at the rider's sole risk.**



WARNING: Extreme Riding

- Vehicles and components are NOT designed for extreme use such as jumps, stunts, or riding beyond your ability.
- Extreme riding may cause component failure, severe injury, or death.

Final Note:

- Always ride responsibly, maintain the Vehicle regularly, and replace components when necessary.
- The rider assumes all risks associated with operating this Vehicle.
- For questions or concerns, contact your authorized EMMO dealer or EMMO Customer Support.

Description

1. Schematic Diagram

a. Side View

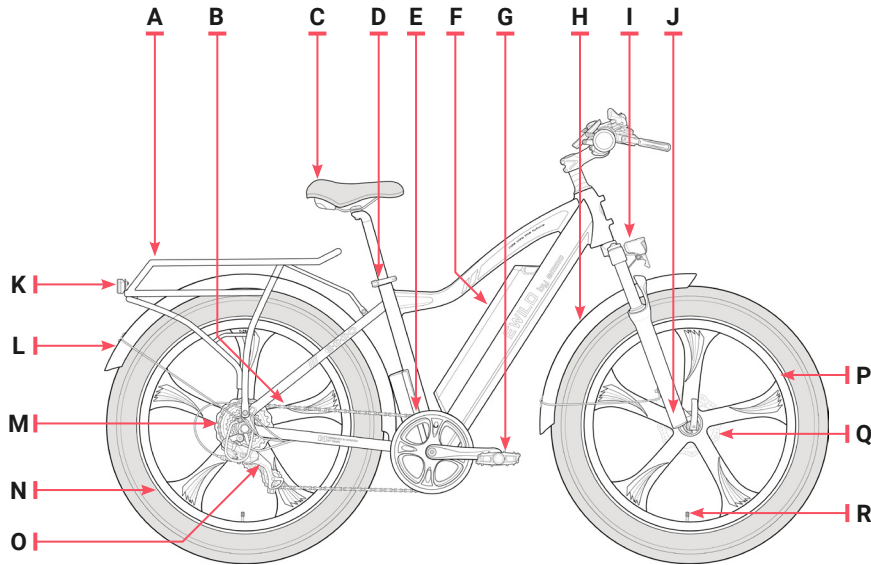

A	Rear Rack
B	Chain
C	Seat Cushion
D	Seat Clip
E	Pedal Crank
F	Battery
G	Pedal
H	Front Fender
I	LED Headlight
J	Front Adjustable Shock
K	Taillight
L	Rear Fender
M	Rear Brake Disk
N	Rear Rim With Motor
O	Derailleur
P	Front Rim
Q	Front Brake Disk
R	Valve

Description

1. Schematic Diagram

b. Handlebar Attachments

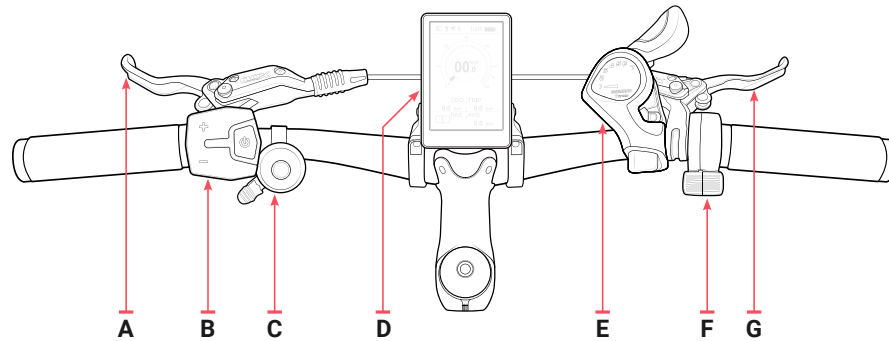

A	Rear Brake Lever
B	Control Button
C	Bell
D	Speedometer
E	Gear Shifter
F	Throttle
G	Front Brake Lever

Operation Guide

1. Speedometer & Control



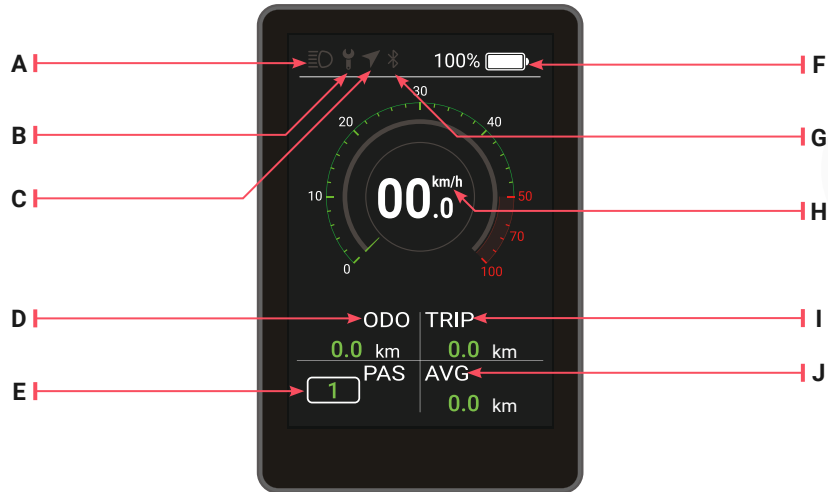







a. Display



Operation Guide

1. Speedometer & Control

a. Display

A		Headlight Indicator	Indicates if the status of the headlight is on/off. The icon lights up when the headlight is on.
B		Maintenance Indicator	Lights up when maintenance is required.
C		Navigation Indicator	The mobile app connects to the display via Bluetooth, and lights up when the mobile app starts to navigate.
D		Total Distance Traveled	Displays the total distance traveled.
E		Pedal Assist Level	Displays the pedal assist level.
F		Battery Level Indicator	Indicates current battery level.
G		Bluetooth Indicator	Bluetooth on/off status display, the icon will light when connected.
H		Real-time speed	Display speed in real-time.
I		Trip Distance	Displays the distance traveled for the current trip.
J		Average Speed	Displays the average speed.

Operation Guide

1. Speedometer & Control

b. Navigation

After connecting to the device via Bluetooth using the **BIKEGO** app on your smartphone, select a destination to start navigation. The main interface will then change as follows:

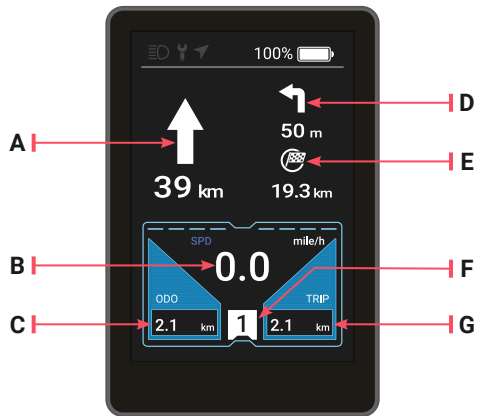

A	Upcoming Turn and Distance
B	Real-Time Speed
C	Total Distance Distance
D	Next Turn and Distance
E	Distance to Destination
F	Pedal Assist Level
G	Trip Distance

Operation Guide

1. Speedometer & Control

c. Control Function

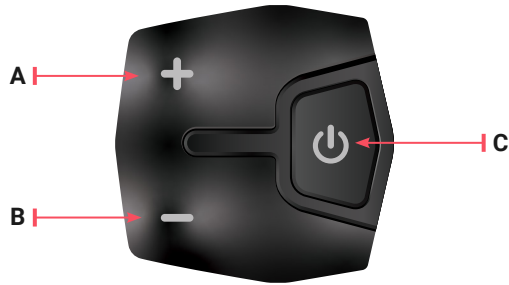

A	Plus + Button
B	Minus - Button
C	Power Button

Power On/Off

Hold the **POWER** button for 1 second to turn on the display and controller. To turn off hold the **POWER** button for 1 second. The display will turn off and the e-bike will no longer have power. If no action on the e-bike, the e-bike will power off. The auto power off can be changed in settings.

Operation Guide

1. Speedometer & Control

d. Function Summary

Enter the Password

You need to press the “+” button or “-” button to enter the password before entering the main interface, the **default password is 0000**.

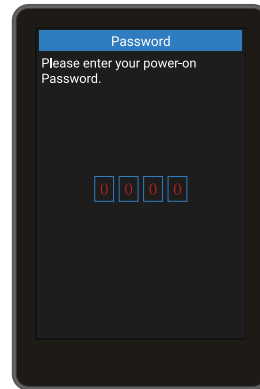
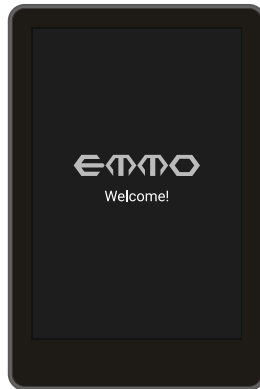

Operation Guide

1. Speedometer & Control

d. Function Summary

Changing the Pedal Assist (PAS) Level

After entering the main interface, press the “+” button or “-” button to switch the PAS level, the default gear of the instrument is 0-5 gear, no power output in level 0, level 1 is the lowest power and level 5 is the highest power. The default is 0 when the instrument is powered on.

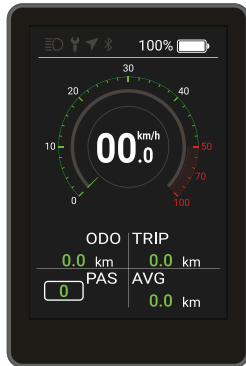

PAS 0



PAS 1

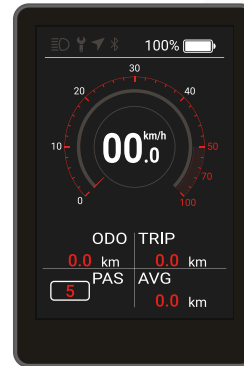

PAS 5

Operation Guide

1. Speedometer & Control

d. Function Summary

Turn ON/OFF Headlight and Taillight

Turn on the light: Hold the “+” button when the light is turned off. The headlight indicator will light up, and the headlight/taillight will be turned on as well.

Turn off the light: Press and hold the “+” button when the light is turned on. The headlight indicator will no longer be lit, and the headlight/taillight will be turned off as well.

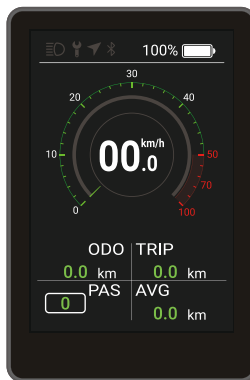

HEADLIGHT INDICATOR

! NOTICE: Once the headlight indicator and headlight/taillight are on, the indicator will dim but not disappear. The indicator will turn off if the e-bike is turned off or if the headlight and taillight are turned off.

Operation Guide

1. Speedometer & Control

d. Function Summary

Walking Mode

When the bike is stationary, switch the PAS level to 0, press the “-” button again to display the icon “”. After the logo appears hold the “-” button to enter walking mode. The interface is shown as follows.

In walking mode, the boost logo is animated, the vehicle speed is less than 6km/h, releasing the “-” button will stop the boost, and the logo will no longer be animated.

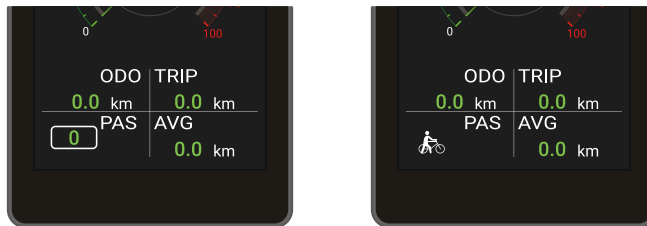

WALKING MODE

Operation Guide

1. Speedometer & Control

d. Function Summary

Press the **Power** button to enter the list of settings, use the “+” button or the “-” button to switch between different setting, press **Power** to confirm selection between “Display Setting”, “Information”, “Language”, “Themes”, “Password”, “Bluetooth” and “Exit”.

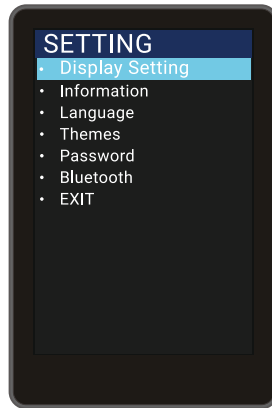

Operation Guide

1. Speedometer & Control

d. Function Summary

Imperial and Metric Unit Conversions

Go to the “Display Setting” menu, select “Unit”, press **Power** to enter the settings. Use the “+” button or the “-” button to move the cursor up and down after entering the settings, and select “Metric” or “Imperial”, press **Power** to save and exit to “Unit”, Exit the menu via “Back” Exit to the main interface.

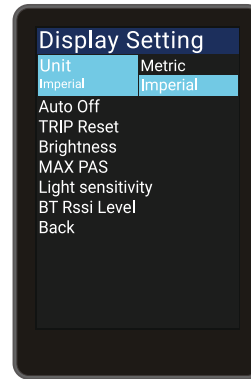

UNIT MILE

! **NOTICE:** The display is in imperial by default.

Operation Guide

1. Speedometer & Control

d. Function Summary

Automatic Shutdown

Go to the “Display Setting” menu, use the “+” button or the “-” button to move the cursor up or down, select “Auto Off”, press **Power** to enter the settings interface, move the cursor to select between “OFF”, “1min”, “2min”, “3min”, “4min”, “5min”, “6min”, “7min”, “8min”, “9min” and “10min” (“OFF” means to turn off the auto-shutdown function, and “1min-10min” indicates the time until shutdown). Press “Save” to exit to the “Display Setting” menu, then through “Back” and “Exit” to return to the main interface.

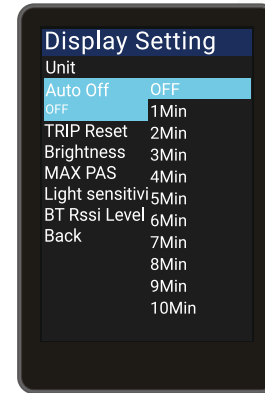

AUTO ON/OFF

! NOTICE: Any operation will reset the internal timer, the bike will only shut down automatically when the preset time is reached.

Operation Guide

1. Speedometer & Control

d. Function Summary

Trip Distance Clearance

Go to the “Display Setting” menu, use the “+” button or the “-” button to move the cursor up or down. Select “Trip Reset”, press **Power** to enter the settings, move the cursor to select between “NO” and “YES”, press **Power** to save and exit to Trip Reset, exit to the main interface via “Back” to “Exit”.

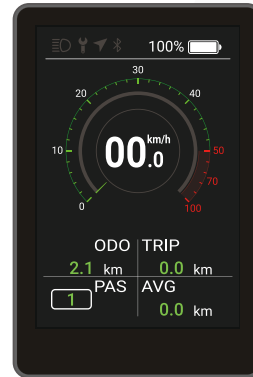
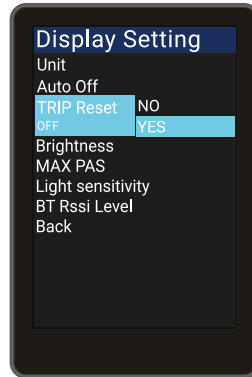

Operation Guide

1. Speedometer & Control

d. Function Summary

Backlight Brightness Settings

Go to the "Display Setting" menu, use the "+" or "-" button to move the cursor up or down. Select "Brightness", and press **Power** to enter the settings. Move the cursor to select the desired brightness level: "10%", "30%", "50%", "75%", or "100%". Press **Power** to save and exit to "Brightness", then exit to the main interface by selecting "Back" and then "Exit".

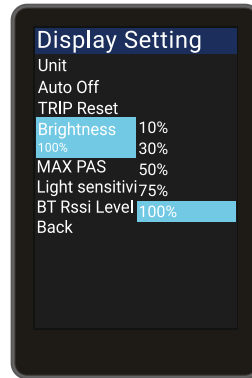

Operation Guide

1. Speedometer & Control

d. Function Summary

Max Pas – Maximum PAS level

The maximum PAS level is not adjustable.

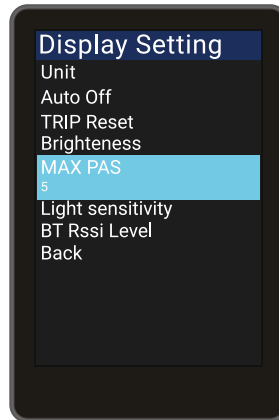

Operation Guide

1. Speedometer & Control

d. Function Summary

Light Sensitive - Light Sensitivity

Go to the "Display Setting" menu, use the "+" button or the "-" button to move the cursor up or down, select "Light sensitive", press **Power** to enter the settings, and move the cursor after entering the settings and select "Off"/"Low"/"Mid"/"High". Selecting "Off" will turn off the auto headlight feature. Press **Power** to save and exit to "Light sensitive", exit to the main interface via "Back" to "Exit".

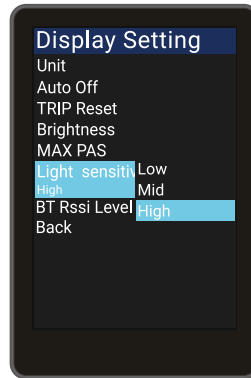

Operation Guide

1. Speedometer & Control

d. Function Summary

BT RSSI Level - Bluetooth Distance Level Setting

The Bluetooth distance level ranges from 1 (near) to 5 (far).

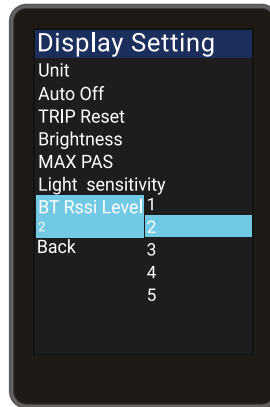

Operation Guide

1. Speedometer & Control

d. Function Summary

Wheel Diameter Information

Programmable Range

16-Inch	410mm
16-Inch Snow	460mm
20-Inch	510mm
20-Inch Snow	570mm
24-Inch	610mm
26-Inch	660mm
26-Inch Snow	710mm
27.5-Inch	700mm
29-Inch	740mm

Enter the "Information" menu, use the "+" button or "-" button to move the cursor up and down, select "Wheel Size", press **Power** to enter the settings, the wheel diameter is set to 26 Inch.

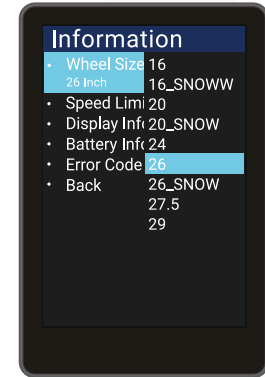
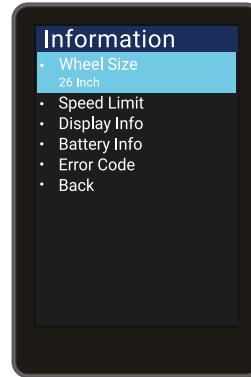

WHEEL SIZE

Operation Guide

1. Speedometer & Control

d. Function Summary

Speed Limit Information

Enter the “Information” menu. When the unit is set to km metric, the speed limit is set to 32km/h by default. When the unit is set to mile imperial, the speed limit is 20MPH. Press **Power** to enter the settings, and the possible range is between 0-100km/h (actual speed is also limited by the controller). Press Power to confirm and return to Information. Exit to the main interface via “Back” to “Exit”.

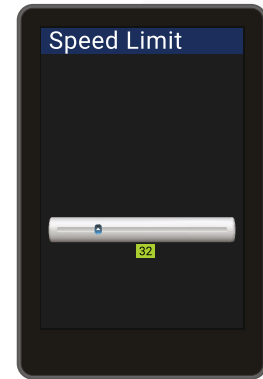
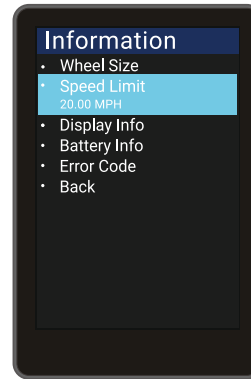

SPEED LIMIT



WARNING: Modifying the speed limit of your bike may be in violation of local laws and result in serious consequences. Before making any changes, it is important to fully comprehend the potential risks and legal liability involved.

Operation Guide

1. Speedometer & Control

d. Function Summary

Instrument Information

Enter the "Information" menu, use the "+" button or "-" button to move the cursor up and down, select "Display Info", click "OK", the instrument interface displays the instrument hardware and software version number, Exit to the main interface via "Back" to "Exit".

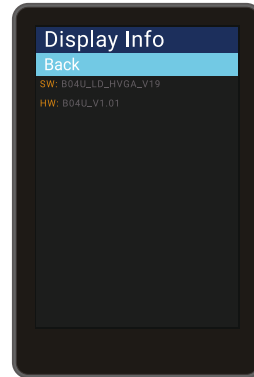
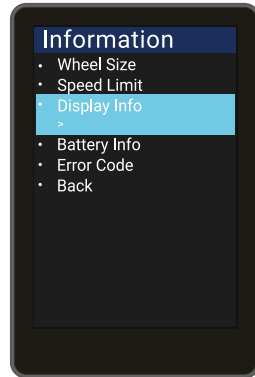

Operation Guide

1. Speedometer & Control

d. Function Summary

Battery Information

Enter the 'Information' menu, switch to 'Battery Info' and press the **Power** button to view the battery information. The battery information is not adjustable. Use 'Back' to exit and return to the main interface.

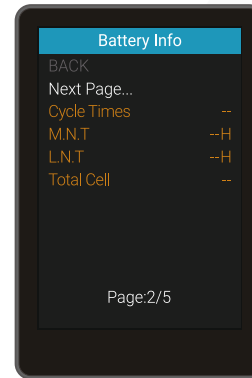
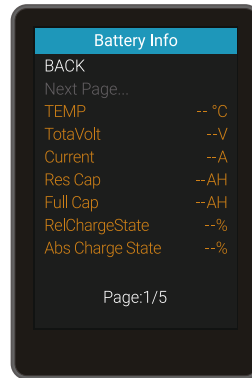
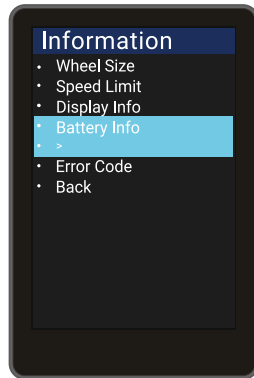

Operation Guide

1. Speedometer & Control

d. Function Summary

Battery Information

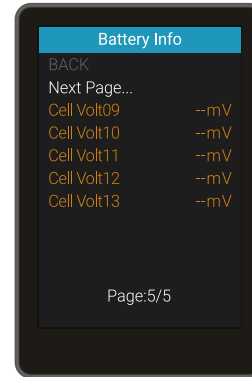
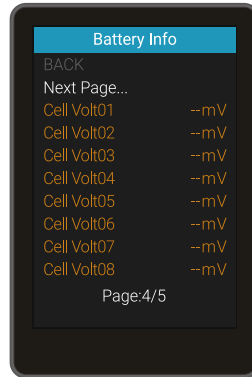
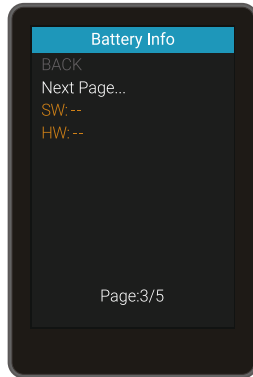

! **NOTICE:** Hardware and software version numbers may change depending on the batch of the product, so it is denoted by "--".

Operation Guide

1. Speedometer & Control

d. Function Summary

Error Code

Go to the “Information” menu, use the “+” button or the “-” button to move the cursor up and down. Select “Error Code” and select the “Back” to “Exit” to exit to the main interface. “E-CODE 0” represents the latest error message, and “E-CODE 9” represents the tenth error. The display can record up to ten error, view them by pressing “+” or “-”.

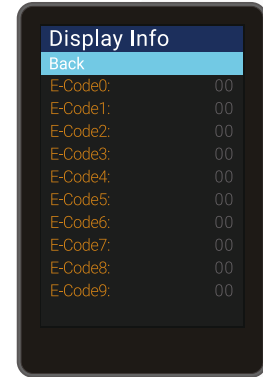
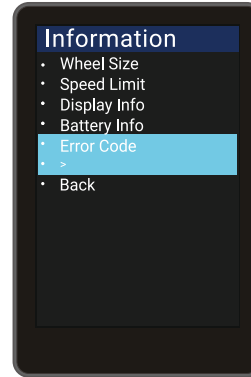

ERROR CODE

! NOTICE: The error code is “00” means that there is no error, please refer to the error code definition table for other codes.

Operation Guide

1. Speedometer & Control

d. Function Summary

Language Selection

There are 3 languages for users to choose. Press the **Power** button to enter the settings, use the “+” button or the “-” button to move the cursor up or down, select “Language”, press **Power** to enter the language selection interface, move the cursor to toggle between “English”, “Español” and “Deutsch” and then press “OK” to exit to the main interface via “Back” to “Exit”.

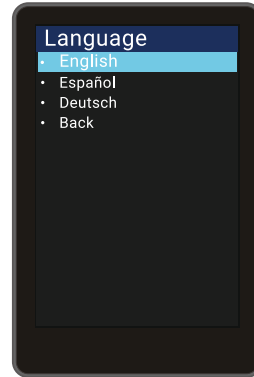
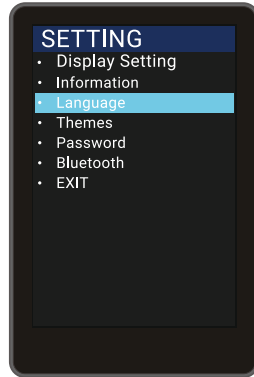

Operation Guide

1. Speedometer & Control

d. Function Summary

Language Selection

There are 4 different themes for users to choose from. Press the **Power** button to enter the settings menu, use the “+” or the “-” button to move the cursor up or down. Select “Themes”, press Power to enter the themes selection interface, and use the “+” button or “-” button to switch between “Theme 1”, “Theme 2”, “Theme 3”, and “Theme 4”.

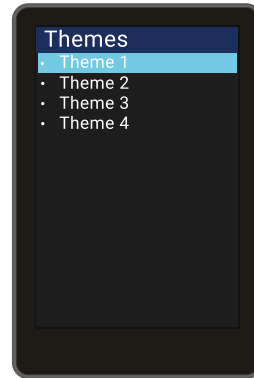
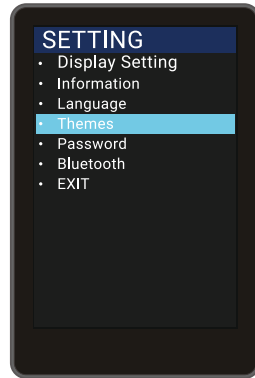

Operation Guide

1. Speedometer & Control

d. Function Summary

Turn Off the Password Function

Press the **Power** button to enter the settings menu, use the “+” button or the “-” button to move the cursor up or down. Select “Password” and press “OK” to enter the password options interface. Use the cursor to select “Start Password” (if it is currently on) and press **Power** to confirm. The interface will then prompt for a password, use the “+” button or the “-” button to toggle the numbers “0-9” and press **Power** to switch between digits. Once the password has been entered, the system will prompt to turn off the password function.

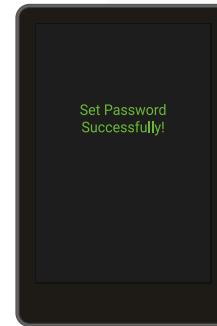
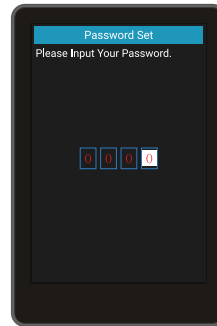
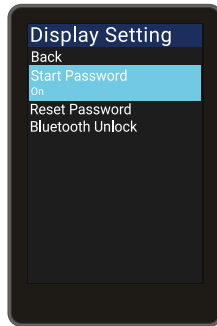
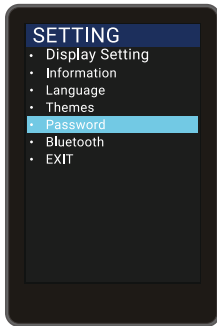

Operation Guide

1. Speedometer & Control

d. Function Summary

Turn On the Password Function

Press the **Power** button to enter the setting information list, use the “+” button or the “-” button to move the cursor up and down, select the “Password” option and press “OK” to enter the Password options interface, select “Start Password” (Start Password status is off) and press **Power** to confirm, the interface prompts for the password, At this time, use the “+” button or the “-” button to toggle the number “0-9”. Press **Power** to confirm the number in the current cursor, and after entering it, the system prompts you to turn on the password function successfully.

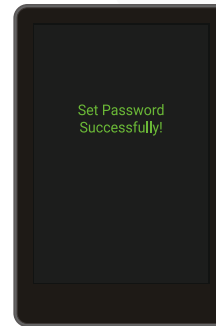
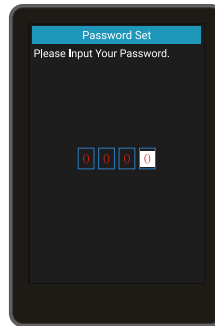
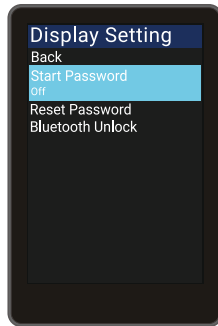
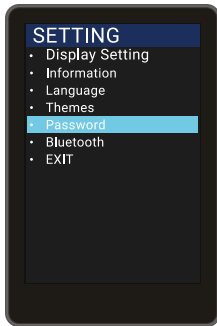

Operation Guide

1. Speedometer & Control

d. Function Summary

Set and Modify Password

Press the **Power** button to enter the setting information list, use the “+” button or the “-” button to move the cursor up and down, check the “Password” option and press “OK” to enter the Password Options interface, move cursor to “Reset Password” and press **Power** to confirm.

- The interface prompts “Please enter your old password”, use the “+” button or the “-” button to toggle the number “0-9” and press **Power** to toggle digits.

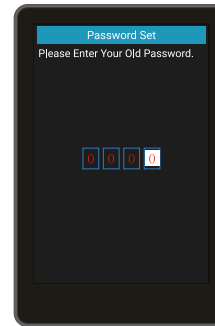
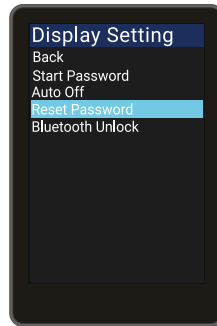
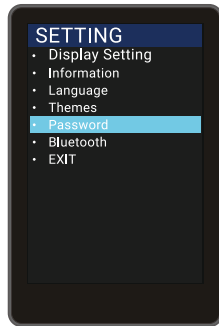

Operation Guide

1. Speedometer & Control

d. Function Summary

- After the old password is entered, the interface will prompt “Please enter your password”, use the “+” button, the “-” button or the **Power** button to enter a new password.
- After the interface prompts “Please confirm your password”. Enter your new password one more time using the 3 function buttons.

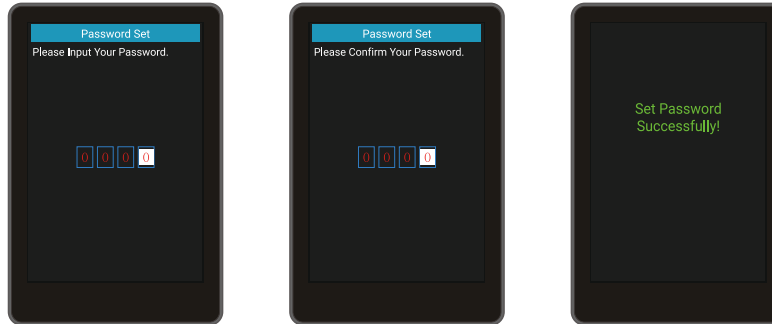

! **NOTICE:** After the initial password is modified, if you want to enable the instrument password function, you need to enter the new password to enable it.

Operation Guide

1. Speedometer & Control

d. Function Summary

Bluetooth Lock Settings (Bluetooth Unlock Is On by Default)

Press the **Power** button to enter the setting information list, use the “+” button or the “-” button to move the cursor up and down, and press “OK” after checking the “Password” option, enter the Password options interface, select “Bluetooth Unlock” press **Power** to enter the settings, press the “+” button or “-” button after entering the settings to select “On” or “Off” (“On” means to turn on the Bluetooth lock, “Off” means to turn off the Bluetooth lock), press “Save” to select and exit.

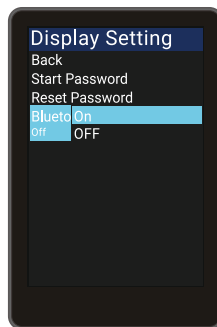
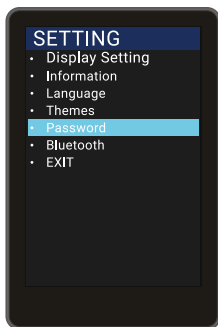

Operation Guide

1. Speedometer & Control

e. Bluetooth APP

Download the APP



BIKEGO

Search "BIKEGO" and install on your mobile device.

To download the **BIKEGO** APP on your mobile device, access either the App Store or Google Play Store, depending on your device's operating system. Then, use the search function to locate the BIKEGO app, click on the "Download" or "Get" button, and follow the prompts to install the app.

! **NOTICE:** Emmo not liable for in-app purchases.

Operation Guide

1. Speedometer & Control

e. Bluetooth APP

Bluetooth Connection

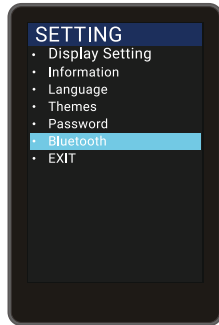

- Tab the **Power** key to enter the setting information list, use the **“+”** key or the **“-”** key to move the cursor up and down, select the **“Bluetooth”** option, and tab **“OK”** to enter the Bluetooth QR code interface.
- Open the BIKEGO APP, click on **“New Bike”** to add your e-bike and scan the QR code on the speedometer of the ebike to connect to your E-Bike.

Operation Guide

1. Speedometer & Control

e. Bluetooth APP

Bluetooth Connection

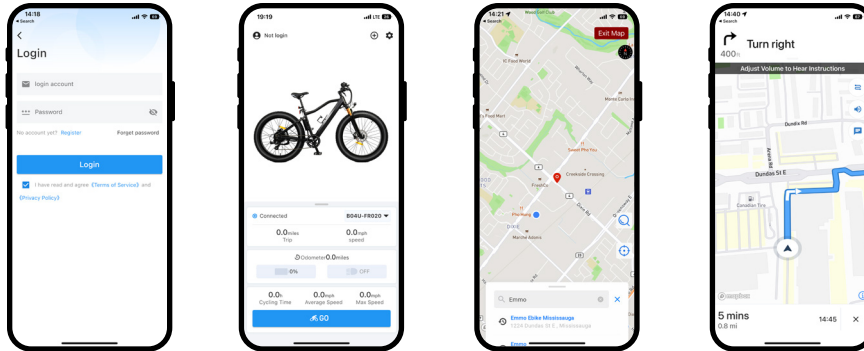

- To create an account, you will need to provide personal information including your name, email address and phone number. Once you have created an account, you can log in and start using the app.
- After entering the main interface, start navigation by pressing 'go,' enter your destination, and you can start your journey.

Operation Guide

1. Speedometer & Control

f. Error Code

When something goes wrong with the system, an error code will flash on the display. Check the details on the attached list. The motor will stop working in the event of an error. Only when the error is gone, will the motor work again.



Error Code	Error Description
04	The throttle is not hosted
05	Throttle failure
07	Over-voltage protection
08	Motor Hall signal line failure
09	Motor phase line failure
10	The temperature inside the motor is too high
11	Motor temperature sensor failure
12	Current sensor failure
13	Temperature failure inside the battery
14	The temperature inside the controller is too high

Operation Guide

1. Speedometer & Control

f. Error Code

Error Code	Error Description	Error Code	Error Description
15	The controller temperature sensor is faulty	42	The total voltage is too low
21	The velocity sensor is faulty	43	The total current is too large
25	Torque sensor torque signal failure	44	The monomer voltage is too high
26	The torque sensor speed signal is faulty	45	Temperature too high (battery)
27	Controller overcurrent	46	Temperature too low (battery)
30	Communication failure	47	The SOC is too high (battery)
33	Brake circuit failures	48	How low the SOC is (battery)
35	15V power supply at fault	61	Transmission jam
36	Key detects circuit faults	62	The transmission cannot be reset
37	Watchdog timer malfunction	71	The electronic lock is stuck
41	The total voltage is too high	81	The transmission cannot be reset

Operation Guide

2. Adjusting the Seat Height

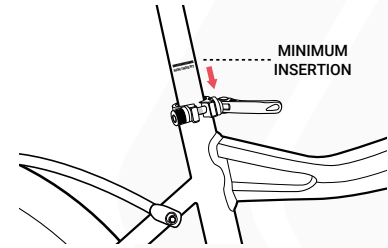
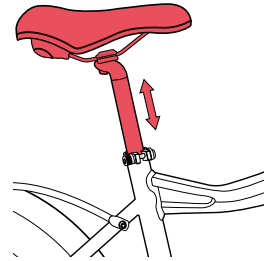
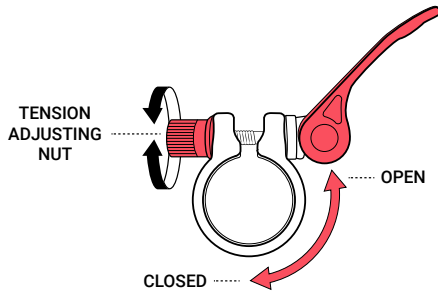

- Unlock the seat clamp, loosen the tension adjusting nut.
- Adjust the seat height to your preferred position and lock the clamp.
- Align the clamp opening with the notch in the seat tube and close the clamp lever fully.
- Closing the clamp should require enough pressure that it leaves an imprint in your hand.



WARNING: There is a **MINIMUM INSERT** marker on the seat post. You must not raise the seat to a higher position than that. Raising the seat post higher will result in injury or damage to property/e-bike.

Operation Guide

3. Adjusting the Saddle Position

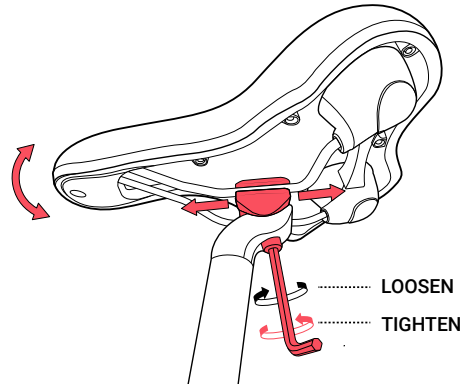

- Loosen the bolt at the bottom.
- Adjust the saddle tilt by pressing down on the front or rear of the saddle.
- Tighten the bolt to secure the saddle.

Operation Guide

4. Battery

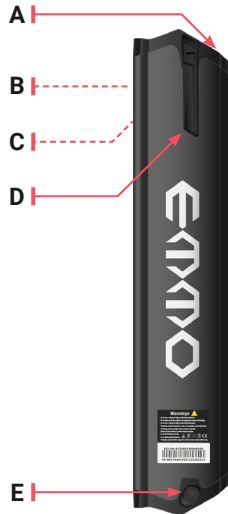

A	Battery Strength Indicator
B	USB Port
C	Discharging Port
D	Battery Lever
E	Battery Charging Port

Operation Guide

4. Battery

a. Battery Strength Indicator

Hold the **POWER** button to see the current battery strength.

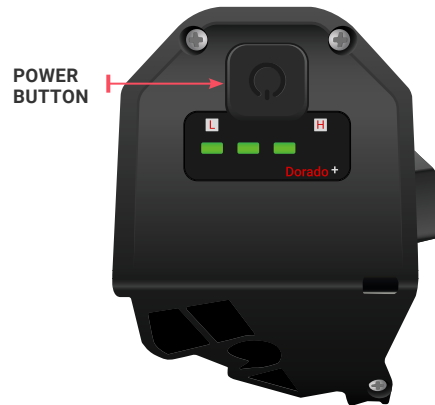

Operation Guide

4. Battery

b. USB Port

The USB port can be used to power or charge an external device like a smartphone. To access the USB port, lift the cover and use the appropriate cable (not included) for your device to connect it.

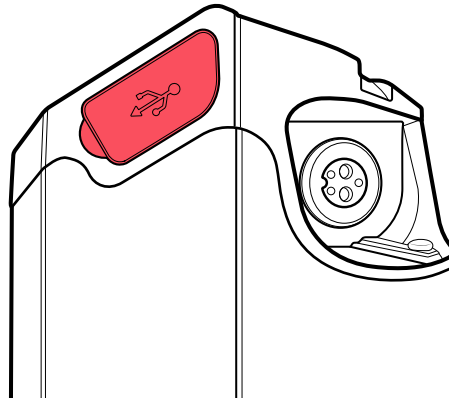

Operation Guide

4. Battery

c. Discharging port

The discharging port for an ebike battery refers to the connector that allows the battery to discharge its stored electrical energy to power the electric motor of the ebike.

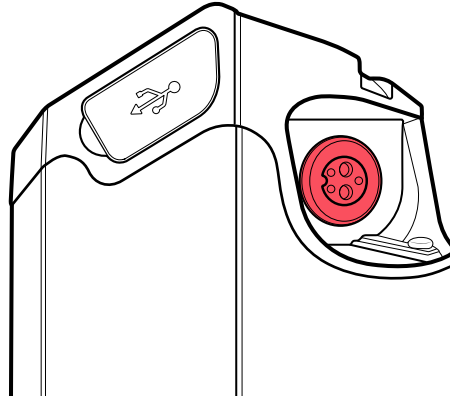

Operation Guide

4. Battery

d. Battery Lever

The battery lever makes it more convenient when you remove the battery.

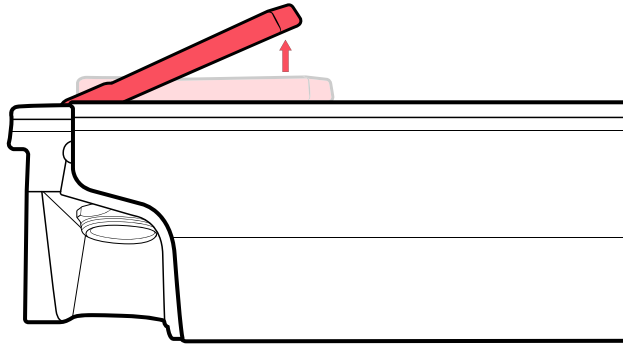

Operation Guide

4. Battery

e. Battery Charging Port

The charging port of the battery is located at the bottom, and you can find it by opening the rubber cover.

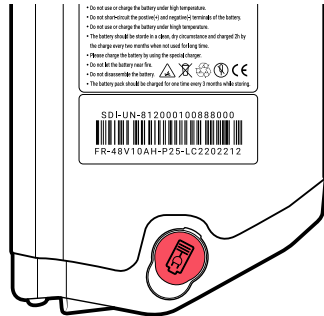

Operation Guide

4. Battery

f. Battery Lock

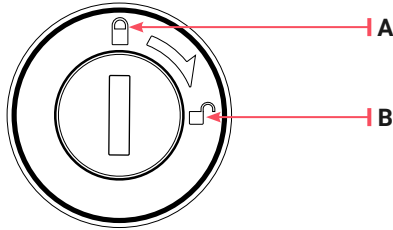

A	Lock
B	Unlock

This is a Two-position switch that is located on the battery:

- Lock
- Unlock

Operation Guide

4. Battery

f. Battery Lock

How to Remove the Battery

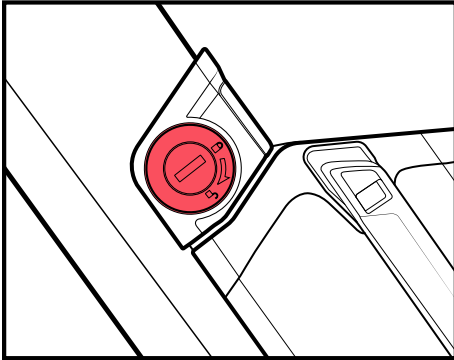

I. The battery lock is located on the bike frame.

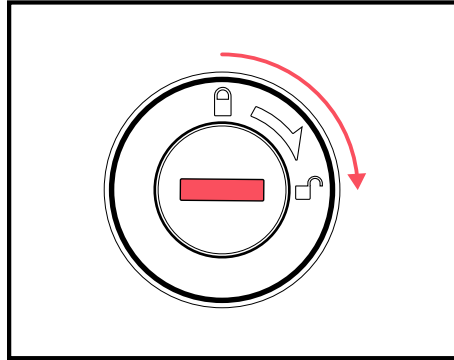

II. Insert the key and turn it to the unlocked position and hold it there.

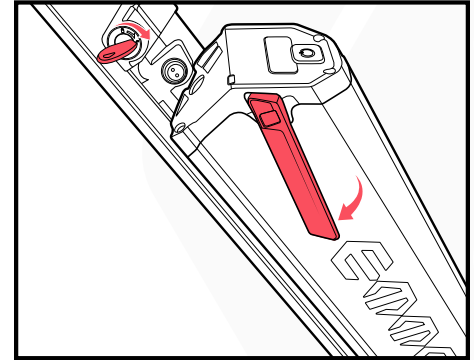

III. Keep the battery lock in unlocked position. Pull the lever out and remove the battery from the bike.

Operation Guide

4. Battery

f. Battery Lock

How to Insert the Battery



IV. Insert the tail end of the battery into frame mount.

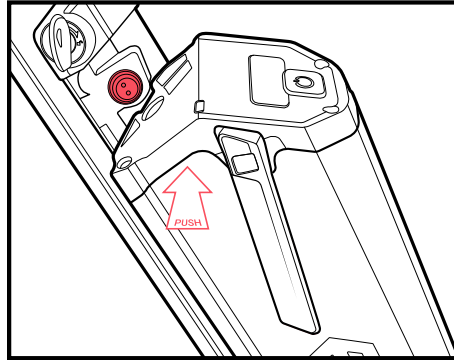

V. Push the top of the battery into the battery connector port until you hear a clicking sound.

Operation Guide

4. Battery

g. Battery Safety Precautions

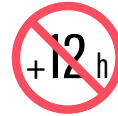

- Be sure to use the original/compatible battery (approved by EMMO). Using batteries from other brands may lead to severe accidents.
- Inspect the battery for any damage, leaking, overheating or smoking.
- Always charge between **0°C to 45°C**, charging outside of this range may cause permanent damage to battery.
- **DO NOT** lift the battery by its connectors or cables.
- **DO NOT** charge the battery for over 12 hours.
- **DO NOT** subject the battery to impact.
- **DO NOT** subject the battery to water.
- **DO NOT** subject the battery to heat or open fire.
- **DO NOT** open the battery pack by yourself. If you need any assistance, please contact your EMMO dealer.

[Refer to: Battery & Charger Safety for proper and safe use of battery & charger](#)

Operation Guide

4. Battery

h. Disposal



This product contains lithium batteries which must be disposed or recycled in an environmentally safe manner. Do not dispose of the batteries in your household trash. Do not dispose of the batteries in a fire, this could cause the batteries to leak or explode. The incineration, disposal in landfill and or placing lithium batteries with household trash is prohibited by law in most areas.

NOTICE:

- Used batteries must be treated as hazardous waste.
- Batteries must be disposed of in accordance with the the regulations set forth by your local government/organizations.
- In case of uncertainty, please contact EMMO customer service department at service@emmo.ca

Operation Guide

4. Battery

i. Storage & Maintenance

- For storage, please disconnect the battery from the bike and charge the battery on a regular basis (at least once a month).
- Battery packs and chargers need to be stored in a clean, dry, well ventilated place, avoid contact with corrosive material, and keep them away from heat and fire.
- Battery storage conditions: temperature: -20 - 35°C , humidity ≤ 65%RH.

Operation Guide

5. Charger

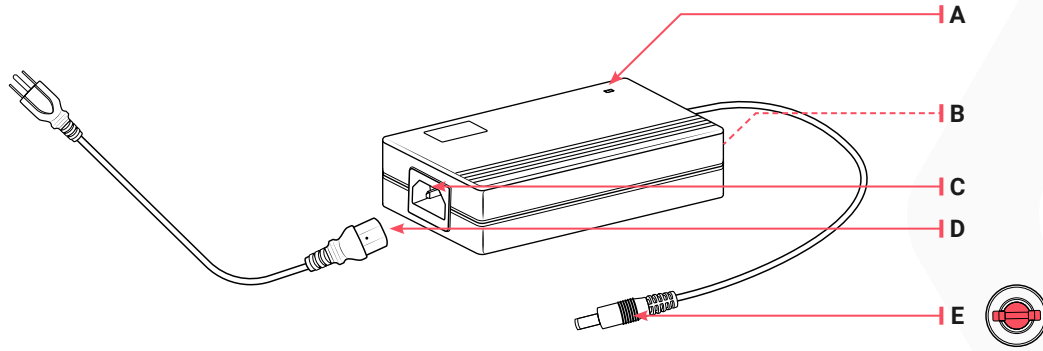

A	Charging Indicator
B	Charger Specification Label
C	Power Cord Socket
D	Power Cord
E	Charging Plug

Operation Guide

5. Charger

a. Charging Indicator

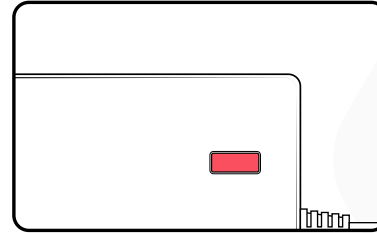
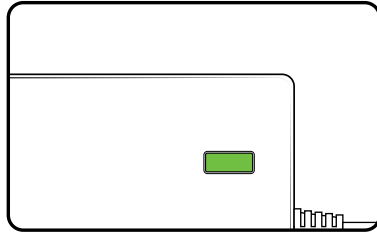

Charging Indicator Explanation:

- During normal charging, red light stays on.
- The indicator will turn green when the battery is fully charged.

! **NOTICE:** If the charger gets warm during regular use, this is normal and is no cause for concern.

Operation Guide

5. Charger

b. Charger Specification Label

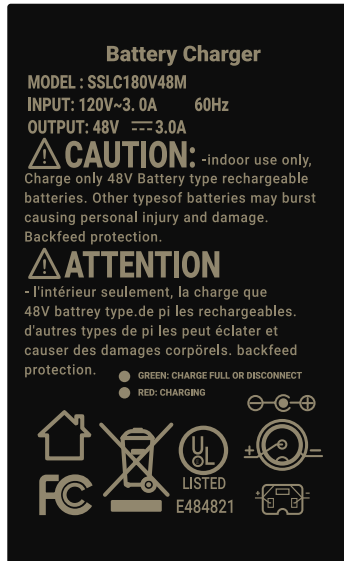

Operation Guide

5. Charger

c. Power Cord Socket

d. Power Cord

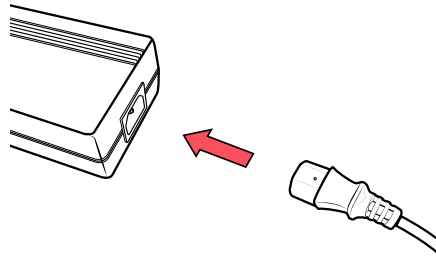

Connecting the charger:

- Plug **d** of the power cable into the device socket **c** on the charger.



WARNING: You **MUST NOT** plug the power cord directly to the bike/battery. High voltage may damage the bike/battery and cause severe injury.

Operation Guide

5. Charger

e. Charger Plug

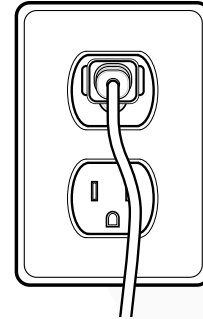
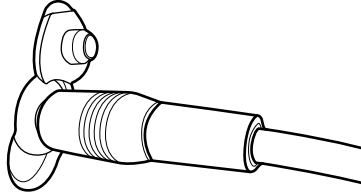
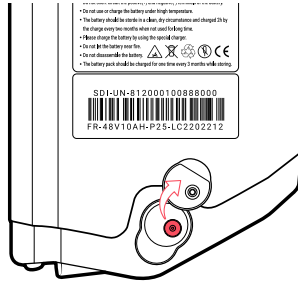

How to charge:

- The charging port is located at the tail end of the battery. (Refer to "[Battery Charge Port](#)" on [Page 56](#).)
- Open the rubber cover of the charging port and then insert the charger.
- Plug the charger into a regular 110V wall outlet.

Operation Guide

5. Charger

f. Charging Precautions



WARNING: Battery & Charger Safety

- The charger should only be used **indoors** in a cool, dry, ventilated area. Always position the charger on a **non-flammable surface** (e.g., concrete or brick), as it may generate heat during peak charging cycles.
- You must use a dedicated 110V outlet to charge your battery.
- Never cover the charger during charging or leave it unattended.
- Keep the battery and charger away from children, pets, water, and open flame.
- DO NOT submerge or allow the charger to be submerged in water or any liquid.
- **DO NOT** use the charger or battery if **any part of the cord, connector, or housing is frayed, cracked, exposed, or otherwise damaged**. Using damaged charging equipment or battery connectors can lead to malfunction, fire, or serious injury.
- Do NOT drop, strike, or expose them to shocks.
- Use only the charger supplied with the product or approved by EMMO.

- Disconnect promptly once fully charged. Do NOT charge for more than **12 hours**, whether the battery is full or not.
- If the battery is stored, check it at least **once a month**. If necessary, use the original charger to recharge the battery to about **75%**. Failure to perform regular checks or charging may result in malfunction or safety hazards.
- Disconnect immediately if there is a strange smell, smoke, or overheating.
- In the unlikely case of battery fire: **never use water**. Use sand to cover the fire and call emergency services.
- **Battery & Charger Rated Life Expectancy:** Lead-Acid Battery: 2 years (500 cycles); Lithium-Ion Battery: 4 years (1000 cycles); Charger: 4 years. All component lifespans assume normal use and proper maintenance. **Annual inspection & safety testing by an authorized technician are required to ensure safety.** Components that have exceeded their rated service life—or no longer provide expected performance—should be replaced to ensure safety and reliability. While proper care may extend usable life, this can NOT be guaranteed.

Operation Guide

6. Gear Shifter

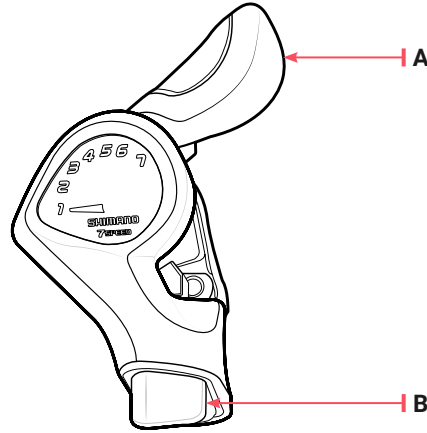



A	Pushing the upper lever to raise the gear (smaller numbers).
B	Pushing the button to lower the gear (bigger numbers).

Operation Guide

7. Throttle

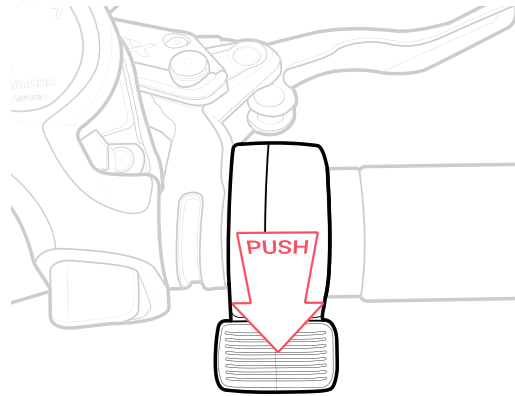
Gently pushing the throttle lever downwards to accelerate.



 **WARNING:** DO NOT press the throttle if you are not ready to ride.

Operation Guide

8. Adjusting the Suspension Fork

The suspension fork can move up and down to cushion bumps, which can make riding on a rough road or trail smoother and more comfortable.

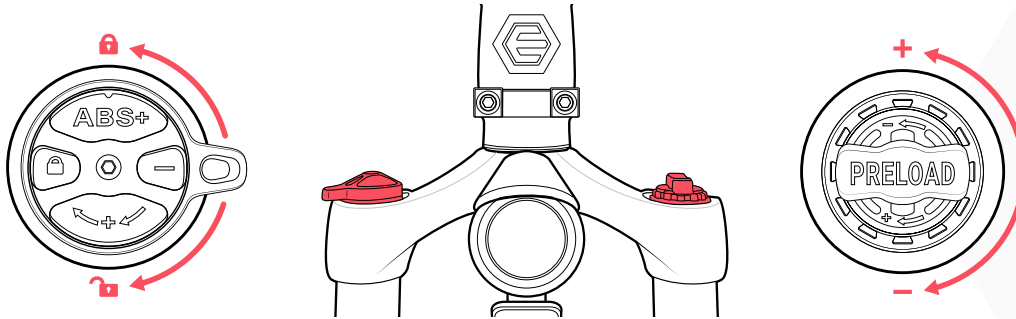

- **Locking the fork** creates a rigid fork fork, which can yield higher efficiency while pedaling and a more predictable ride depending on conditions such as terrain and cargo load.
- **Adjusting the preload** dial makes the fork softer, feel smoother, and more comfortable when riding on a rough road or trail surface.

Operation Guide

9. Cleaning / Lubricating the Chain

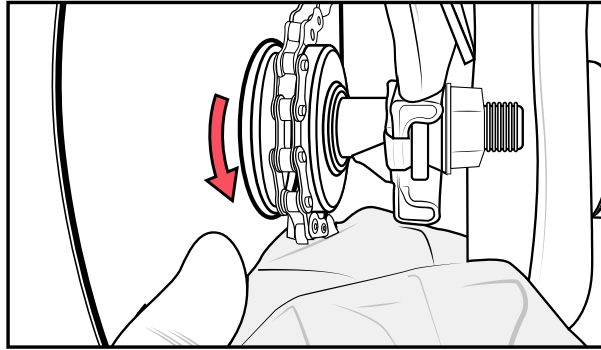

How to Clean the Chain:

- Put the bike on a service stand or lean the bike on the kick/side stand. Make sure the back wheel is off the ground.
- Locate the chain on the right side of the bike, near the rear wheel hub.
- Hold a clean cloth to the chain (as shown).
- Turn the pedal to clean the chain.
- Apply new bicycle chain oil to the sprocket and chain.

Operation Guide

10. Tire Pressure

It is recommended to check the tire pressure on a regular basis to keep things at their best working conditions.

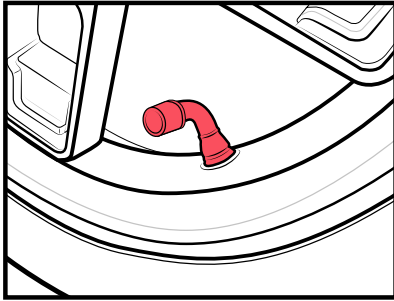

I. Locate the valve on the rim.

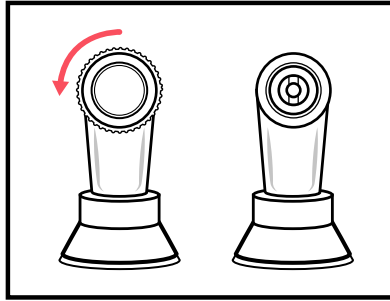

II. Remove the valve cap.

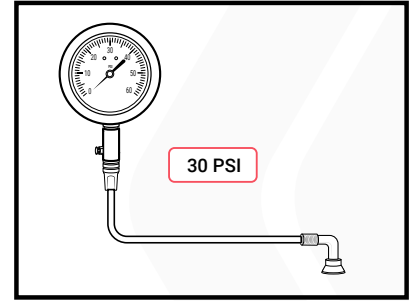

III. Use an air pump with gauge to adjust the tire pressure to 30 PSI.

Tire pressure affects the following:

- Service life of the tires and other components of the bike.
- Riding safety.

Operation Guide

10. Tire Pressure

- Riding comfort
- Travel distance



WARNING:

- You **MUST** inflate the tire to the recommended tire pressure before the first ride. Failure to do so may damage your bike and void your warranty.
- **DO NOT** over-inflate, as this could damage the tire or wheel. (The recommended tire pressure range is marked on both tires by the manufacturers.)

Operation Guide

11. Serial Number

a. Frame Number

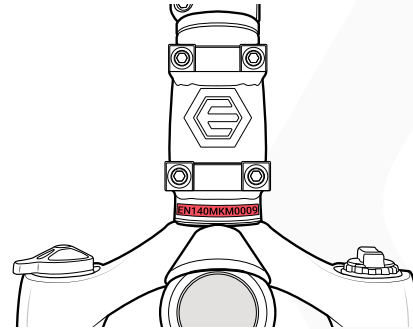
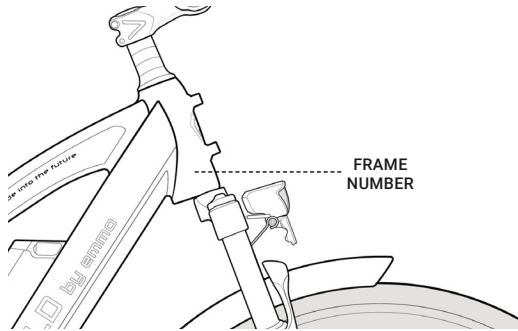

Find the Frame Number:

- The frame number is engraved on the neck of the frame.

Operation Guide

11. Serial Number

b. Motor Number

Located on the motor.

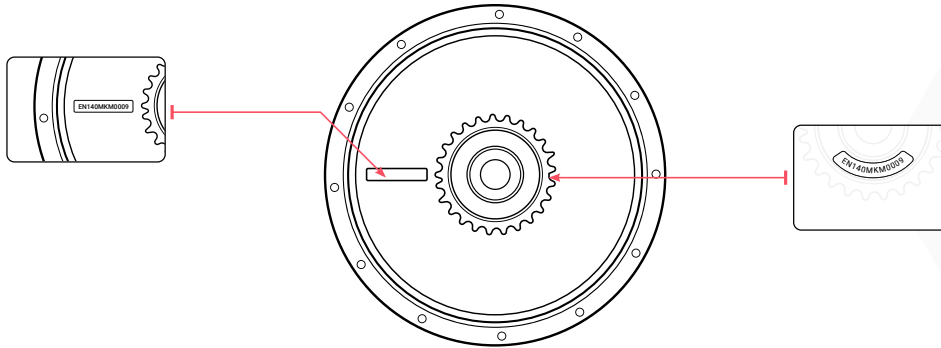

The motor number could be located at the following locations:

- **Location 1:** On the motor cover plate.
- **Location 2:** Behind the sprocket on the motor.

Troubleshooting

Potential Issues/Errors	Most Common Way To Solve Issue
Battery not fully seated in tray	Install battery correctly
Insufficient battery power	Need to recharge/test.
Faulty connections	Reinstalling or testing battery/wiring.
Improper turn on sequence	Clean and reconnect connectors
Brakes are applied	Try restarting the ebike.
Electrical cable unplugged	Repair or replace
Walk mode stopped	Ensure nothing is keeping any button(s) other than the walk mode button pressed on the UI Remote (on some models)
Control button(s) held	Ensure nothing is keeping any button(s) pressed on the UI Control (on some models)
Battery non-functional	Replace battery
Damaged or disconnected pedal assist sensor	Replace or reconnect pedal assist sensor
Loose wiring	Repair and or reconnect
Loose or damaged throttle	Tighten or replace
Loose or damaged motor plug wire	Secure or replace motor plug wire
Damaged motor	Repair or replace

Troubleshooting

Low or faulty battery	Check connection, charge or replace battery
Low tire pressure	Adjust tire pressure
Climbing too many hills, strong headwind, braking, and/or excessive load	Adjust your route or assist with pedals
Brakes rubbing	Adjust the brakes
Battery discharged for long period of time without regular charges, battery is aged, damaged, or unbalanced	If range decline persists; contact local dealer
Insufficient battery power	Charge or replace battery
Loose or damaged motor wiring	Reconnect or replace motor
Loose or damaged wheel spokes or rim	Tighten, repair, or replace
Battery damaged	Replace
Charger not well connected	Adjust the connections
Charger damaged	Replace
Wiring damaged	Repair or replace
Blown charger fuse	Replace charger fuse

 **NOTICE:** If you have any questions, please contact your local dealer.

Recommended Torque Values

Area		Tool	Rec. torque
Handlebar	Stem clamp bolts	5 mm Allen	10 Nm
	Stem faceplate bolts	5 mm Allen	6 Nm
	Stem angle adjustment bolt (side)	5 mm Allen	12 Nm
	Stem angle adjustment bolt (bottom)	5 mm Allen	15 Nm
	Speedometer clamp bolts	3 mm Allen	3 Nm
	Remote clamp bolt	3 mm Allen	3 Nm
	Throttle clamp bolt	3 mm Allen	3 Nm
	Shifter clamp bolt	Phillips or flat head	6 Nm
	Brake lever clamp bolts	5 mm Allen	6 Nm
Brake	Caliper adapter to frame	5 mm Allen	6–8 Nm
	Caliper to adapter	5 mm Allen	6–8 Nm
	Brake pads to caliper	Cotter pin	n/a
	Brake rotor to hub	T25 Torx bit	7 Nm
Seat	Seat adjustment bolt	6 mm Allen	15 Nm

Recommended Torque Values

Frame Downtube	Controller mounting bolts	6 mm Allen	3 Nm
	Frame cable cover bolts	2.5 mm Allen	tighten securely; do not overtighten
Rear dropout	Rear axle nuts	18 mm wrench	40 Nm
	Torque arm bolt	4 mm Allen	5 Nm
	Derailleur hanger mounting bolt	5 mm Allen	10 Nm
	Derailleur mounting bolt	5 mm Allen	10 Nm
	Derailleur cable clamp bolt	5 mm Allen	6-8 Nm
Bottom bracket and crank	Pedal into crank arm	15 mm pedal wrench	35 Nm
	Crank arm removal info	Crank puller for square taper bottom bracket	n/a
	Crank arm bolt into bottom bracket spindle	8 mm Allen	35 Nm
	Freewheel removal	Contact local dealer	n/a
	Chainring bolts	5 mm Allen	10 Nm
	Kickstand mounting bolts	5 mm Allen	8 Nm
	Bottom bracket and cups	BBT-22 Park Tool	60 Nm

Tools and Torque Values

Accessories	Headlight/front fender mounting bolt	5 mm Allen and 10 mm wrench	6 Nm
	Fender mounting bolts (except at headlight)	4 mm Allen	6 Nm
	Replaceable rear rack mounting bolts	5 mm Allen	6 Nm

Riding Guide

1. Checking List Before Riding

- Whether the handlebar is stable and flexible when turning.
- Whether the right and left switches on the handlebar can work properly or not.
- Whether the throttle can work properly or not.
- Make sure the tires are inflated to the recommended tire pressure (30 PSI).
- Check tire surface, make sure there are no cracks, damages, and foreign matter punctures or attachments.
- Check whether the tread depth is enough, for your safety, tires should be replaced when the tread depth is below the recommended value by the manufacturer.
- Whether any error warning light are on the speedometer.
- Whether the battery capacity is enough for your trip.
- Whether all lights work properly or not.
- Whether the horn works properly or not.
- Whether the mirrors are clean and adjusted to the appropriate angle.
- Whether the brake lever and brake system work properly or not.

Warranty Policy

By purchasing any Emmo Inc products or other brand items sold by Emmo Inc, the customer agrees to the policies and procedures outlined below.

Terms and conditions apply for eligibility of warranty. Please refer to [Terms and Conditions](#).

Any warranty is extended to the original owner with the original purchase paperwork. This portion does not cover the purchase of parts or the purchase of products sold by Emmo Inc that is not an electric bike, electric scooter ebike, electric motorcycle style ebike, electric mobility scooter, kick-style electric scooter, or ride-on toy.

Electric Bicycle

Emmo dealers may charge an assembly fee to assemble the ebike.

- **Comprehensive Warranty (up to 4000km)** There is a Two Year warranty (up to 4000km) for the frame, and motor. One year repair or part replacement is extended to the original owner on controller and other applicable components against manufacturer's defect in workmanship and materials on the e-bikes.
- **Manufacturer's comprehensive warranty** does not cover such parts including, but not limited to: seats, plastic housings and shrouds, pitting, scratches and chips, brake pads, tires, tubes, or damage due to lack of maintenance, accident, misuse or abuse. Damage incurred from water, road salt and other foreign debris or chemicals are not covered by the comprehensive warranty. The labour of any warranty repair will be covered by the original store that the bike was purchased from only when it is being repaired at said store. The parts will be covered by Emmo Inc. You are responsible for providing original purchase paperwork and shipping the item to and from the store.

- Twelve Month Warranty (up to 4000km) 12 Month warranty on original Batteries and Chargers provided that they have been maintained as instructed by your vehicle hand-book and not subjected to freezing temperatures. For Lithium models, the chargers must match the lithium batteries. Emmo is not responsible for any damage resulting from using another brand or voltage of charger. The customer is responsible for providing original purchase paperwork and shipping the item to and from the store.
- If you are not able to bring the ebike to the location you purchased from, you may be required to ship the item and a copy of your purchase paperwork to Emmo Inc before receiving a replacement item. You are responsible for shipping to Emmo Inc. Once the warranty claim is approved, Emmo Inc will arrange the shipping for the replacement parts and cover the return shipping to you unless expressed otherwise by Emmo Inc. Labour will not be covered by Emmo Inc.
- Certain conditions that may limit or completely void the warranty of your e-bike are: altering the ebike from its original design or its intended use, eg: pulling a trailer, as a delivery vehicle or any commercial use.

Purchased Parts

Please consult your Emmo dealer for more details of the parts policies.

- **Shipping Damage:** Emmo Inc will not be held responsible for any lost, stolen, or damaged items due to any delivery services or courier actions. Report any damage to Emmo Inc within 7 days of receiving the part with pictures for any shipping damage and proof of purchase. Please note the damage on the shipper's proof of Delivery prior to signing off on the shipment. Shipping damage is not covered by Emmo Inc if you choose your own shipping method or freight forwarder. The cost of shipping will not be covered under warranty unless Emmo Inc agrees in writing to cover the shipping cost.
- **Repair and Store Purchases of Emmo Inc Products:** Any warranty is extended to the original owner with the original purchase paperwork. Any return or exchange within 7 days must be in new, unused, and original

packaging. The customer is responsible for notifying Emmo Inc of the return or exchange and the cost of shipping will not be covered under warranty unless Emmo Inc agrees in writing to cover the shipping cost. On all return and exchange items, a restocking fee of 20% will be withheld from the refund amount unless Emmo Inc has agreed to another arrangement in writing. The cost of the item minus the restocking fee will be refunded once the product is returned and determined to be returnable. Restocking fees are 20% of MSRP not including Taxes, Freight/Shipping or PDI. Items out of original packaging will not be accepted.

- **Part Warranty Policy:** All items with warranty must have a valid warranty sticker. For Lithium models, the chargers must match the lithium batteries. Emmo is not responsible for any damage resulting in using another brand or voltage of charger or using an Emmo item with items that are not sold by Emmo Inc. Within 7 days, any items defective by manufacturer quality and are under warranty can be replaced. After 7 days, any items defective in manufacturer quality and are under warranty can be repaired. Warranty does not cover damage due to lack of maintenance, accident, misuse or abuse. Damage incurred from water, road salt and other foreign debris or chemicals. The labour of any warranty repair will be covered by the original store that the Emmo Inc part was purchased from only when it is being repaired at said store. For repairs that are done on items that are not from Emmo Inc, only a 7-day Parts Warranty will be included.
- If the part was paid by financing, you are responsible for any cancellation fees or penalties charged by the third party financing company unless Emmo Inc has agreed to cover the fees in writing. The financing loan agreement will only be cancelled after Emmo Inc has received and approved the returned item.
- For repairs that are done on items that are not from Emmo Inc, only a 7-day Parts Warranty will be included. Emmo Inc is not responsible for items modified from its intended use or purpose resulting in damage to the ebike or injury to the customer or third party.

 **NOTICE:** If you have any questions, please contact your local dealer.

E-Bike Registration

Once you have purchased an EMMO E-Bike, you can register your vehicle with us to validate your warranty. In order to register your E-Bikes, please follow the steps listed below:

1. Fill out the following form:

E-BIKE REGISTRATION	
Invoice Number:	
Store Location:	
Customer Name:	
Address:	
Phone Number:	
Email:	

E-Bike Registration

Survey:

How did you find out about EMMO Inc.? (Please select the options that apply)

- Returning Customer
- Family / Friend
- Passing by Store
- Kijiji
- TERA
- Google
- Yelp
- Other _____

2. Send the information listed above to our email: info@emmo.ca

3. Wait for a confirmation e-mail from EMMO Inc.

Leave Us a Review

By sharing your experience with EMMO, you can extend your warranty for an extra **3 months for FREE**.

Your review will help us to continue providing great products and services, and help others understand how EMMO can make their life greener.

Thank you for choosing EMMO.

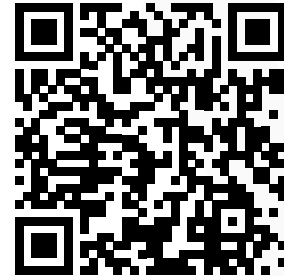

Scan the QR code to
leave us a review.

Contact Us

LOCATION

EMMO Mississauga

1224 Dundas St E, Unit 6
Mississauga, ON L4Y 2C5
Canada

EMMO Vaughan

1750 Steeles Avenue West, Unit 15-17
Concord, ON L4K 1S6
Canada

Contact

Toll Free: +1-888-217-1217

Email: service@emmo.ca

EMMO Toronto

438 Spadina Ave, Unit 2
Toronto, ON M5T 2G8
Canada

Toronto Service Center

8 Oxford Street
Toronto, ON M5T 2G8

Website

www.emmo.ca

www.emmo.ca/pages/contactus



WWW.EMMO.CA

